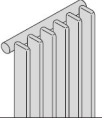
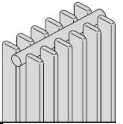

Модель E1...

 Модель	Высота, мм	Межцентровое расстояние N мм	Глубина мм	Расстояние между элементами мм	Вес, кг/сек	Теплоотдача, Watt		Цена в Евро 01,04,08 RAL 9016		Цена в Евро 01,04,08 цвет		Цена в Евро 01,04,08 Металлик	
						Δt 50	Δt 60	за радиатор	за секцию	за радиатор	за секцию	за радиатор	за секцию
E1040/3	400	360	92	30	0,61	25,6	32,2	85	14	98	16	111	18
E1040/4	400	360	92	40	0,63	27,9	35,0	85	14	98	16	111	18
E1040/5	400	360	92	50	0,65	30,3	38,2	85	14	98	16	111	18
E1040/6	400	360	92	60	0,68	32,0	40,2	85	14	98	16	111	18
E1050/3	500	460	92	30	0,73	31,0	39,0	85	15	98	18	111	20
E1050/4	500	460	92	40	0,76	33,5	42,2	85	15	98	18	111	20
E1050/5	500	460	92	50	0,78	36,5	46,1	85	15	98	18	111	20
E1050/6	500	460	92	60	0,81	38,4	48,2	85	15	98	18	111	20
E1060/3	600	560	92	30	0,85	36,2	45,7	85	17	98	19	111	21
E1060/4	600	560	92	40	0,89	39,1	49,2	85	17	98	19	111	21
E1060/5	600	560	92	50	0,91	42,6	53,8	85	17	98	19	111	21
E1060/6	600	560	92	60	0,94	44,7	56,1	85	17	98	19	111	21
E1070/3	700	660	92	30	0,98	41,4	52,3	85	18	98	20	111	23
E1070/4	700	660	92	40	1,02	44,6	56,1	85	18	98	20	111	23
E1070/5	700	660	92	50	1,04	48,6	61,5	85	18	98	20	111	23
E1070/6	700	660	92	60	1,07	50,9	63,9	85	18	98	20	111	23
E1080/3	800	760	92	30	1,11	46,6	58,8	85	19	98	22	111	25
E1080/4	800	760	92	40	1,15	50,0	63,0	85	19	98	22	111	25
E1080/5	800	760	92	50	1,17	54,6	69,1	85	19	98	22	111	25
E1080/6	800	760	92	60	1,19	57,0	71,7	85	19	98	22	111	25
E1090/3	900	860	92	30	1,25	51,7	65,2	85	20	98	23	111	26
E1090/4	900	860	92	40	1,28	55,5	69,9	85	20	98	23	111	26
E1090/5	900	860	92	50	1,30	60,6	76,7	85	20	98	23	111	26
E1090/6	900	860	92	60	1,32	63,1	79,4	85	20	98	23	111	26
E1100/3	1000	960	92	30	1,39	56,8	71,0	85	22	98	25	111	28
E1100/4	1000	960	92	40	1,41	60,9	76,0	85	22	98	25	111	28
E1100/5	1000	960	92	50	1,43	66,6	84,0	85	22	98	25	111	28
E1100/6	1000	960	92	60	1,45	69,3	82,0	85	22	98	25	111	28
E1120/3	1200	1160	92	30	1,64	66,9	84,5	85	24	98	28	111	31
E1120/4	1200	1160	92	40	1,66	71,8	90,6	85	24	98	28	111	31
E1120/5	1200	1160	92	50	1,69	78,5	99,6	85	24	98	28	111	31
E1120/6	1200	1160	92	60	1,71	81,6	102,8	85	24	98	28	111	31
E1150/3	1500	1460	92	30	2,03	82,0	103,7	85	28	98	33	111	37
E1150/4	1500	1460	92	40	2,05	88,4	111,8	85	28	98	33	111	37
E1150/5	1500	1460	92	50	2,08	96,8	122,8	85	28	98	33	111	37
E1150/6	1500	1460	92	60	2,10	100,4	126,8	85	28	98	33	111	37
E1180/3	1800	1760	92	30	2,42	97,3	123,2	85	32	98	37	111	41
E1180/4	1800	1760	92	40	2,44	105,5	133,7	85	32	98	37	111	41
E1180/5	1800	1760	92	50	2,47	115,4	146,8	85	32	98	37	111	41
E1180/6	1800	1760	92	60	2,49	119,9	151,7	85	32	98	37	111	41
E1200/3	2000	1960	92	30	2,70	107,5	136,2	85	34	98	40	111	45
E1200/4	2000	1960	92	40	2,70	117,3	148,7	85	34	98	40	111	45
E1200/5	2000	1960	92	50	2,73	128,2	163,2	85	34	98	40	111	45
E1200/6	2000	1960	92	60	2,75	133,3	168,8	85	34	98	40	111	45
E1220/3	2200	2160	92	30	2,94	117,9	149,5	85	35	98	41	111	46
E1220/4	2200	2160	92	40	2,96	129,3	164,1	85	35	98	41	111	46
E1220/5	2200	2160	92	50	2,99	141,3	180,0	85	35	98	41	111	46
E1220/6	2200	2160	92	60	3,01	147,0	186,5	85	35	98	41	111	46
E1250/3	2500	2460	92	30	3,33	133,7	169,6	85	41	98	47	111	53
E1250/4	2500	2460	92	40	3,35	147,9	188,1	85	41	98	47	111	53
E1250/5	2500	2460	92	50	3,38	161,5	206,0	85	41	98	47	111	53
E1250/6	2500	2460	92	60	3,40	168,4	214,0	85	41	98	47	111	53

**Модель E2...**

 Модель	Высота, мм	Межцентровое расстояние N мм	Глубина мм	Расстояние между элементами мм	Вес, кг/сек	Теплоотдача, Watt		Цена в Евро 01,04,08 RAL 9016		Цена в Евро 01,04,08 цвет		Цена в Евро 01,04,08 Металлик	
						Δt 50	Δt 60	за радиатор	за секцию	за радиатор	за секцию	за радиатор	за секцию
E2040/3	400	360	149	30	1,13	44,2	56,1	170	28	196	32	221	36
E2040/4	400	360	149	40	1,15	47,8	60,7	170	28	196	32	221	36
E2040/5	400	360	149	50	1,18	50,3	63,8	170	28	196	32	221	36
E2040/6	400	360	149	60	1,20	52,6	66,6	170	28	196	32	221	36
E2050/3	500	460	149	30	1,39	52,8	67,1	170	31	196	35	221	40
E2050/4	500	460	149	40	1,41	57,6	73,1	170	31	196	35	221	40
E2050/5	500	460	149	50	1,44	60,9	77,2	170	31	196	35	221	40
E2050/6	500	460	149	60	1,46	63,9	80,9	170	31	196	35	221	40
E2060/3	600	560	149	30	1,65	61,2	77,7	170	33	196	38	221	43
E2060/4	600	560	149	40	1,67	67,2	85,3	170	33	196	38	221	43
E2060/5	600	560	149	50	1,70	71,2	90,3	170	33	196	38	221	43
E2060/6	600	560	149	60	1,72	75,0	95,0	170	33	196	38	221	43
E2070/3	700	660	149	30	1,91	69,3	88,1	170	36	196	41	221	46
E2070/4	700	660	149	40	1,93	76,5	97,2	170	36	196	41	221	46
E2070/5	700	660	149	50	1,98	81,4	103,3	170	36	196	41	221	46
E2070/6	700	660	149	60	2,00	85,9	108,9	170	36	196	41	221	46
E2080/3	800	760	149	30	2,17	77,4	98,3	170	38	196	44	221	50
E2080/4	800	760	149	40	2,19	85,8	109,0	170	38	196	44	221	50
E2080/5	800	760	149	50	2,22	91,6	116,2	170	38	196	44	221	50
E2080/6	800	760	149	60	2,24	96,7	122,6	170	38	196	44	221	50
E2090/3	900	860	149	30	2,43	85,3	108,5	170	40	196	46	221	52
E2090/4	900	860	149	40	2,45	94,9	120,6	170	40	196	46	221	52
E2090/5	900	860	149	50	2,48	101,6	129,0	170	40	196	46	221	52
E2090/6	900	860	149	60	2,50	107,5	136,3	170	40	196	46	221	52
E2100/3	1000	960	149	30	2,69	92,2	118,0	170	43	196	50	221	56
E2100/4	1000	960	149	40	2,71	104,0	131,0	170	43	196	50	221	56
E2100/5	1000	960	149	50	2,74	112,0	141,0	170	43	196	50	221	56
E2100/6	1000	960	149	60	2,76	118,0	148,0	170	43	196	50	221	56
E2120/3	1200	1160	149	30	3,21	108,9	138,7	170	48	196	55	221	63
E2120/4	1200	1160	149	40	3,23	121,9	155,1	170	48	196	55	221	63
E2120/5	1200	1160	149	50	3,26	131,7	167,4	170	48	196	55	221	63
E2120/6	1200	1160	149	60	3,28	139,5	177,0	170	48	196	55	221	63
E2150/3	1500	1460	149	30	3,99	132,5	169,0	170	57	196	65	221	74
E2150/4	1500	1460	149	40	4,01	148,6	189,2	170	57	196	65	221	74
E2150/5	1500	1460	149	50	4,03	161,9	206,0	170	57	196	65	221	74
E2150/6	1500	1460	149	60	4,06	171,4	217,7	170	57	196	65	221	74
E2180/3	1800	1760	149	30	4,77	156,3	199,6	170	64	196	73	221	83
E2180/4	1800	1760	149	40	4,79	175,2	223,2	170	64	196	73	221	83
E2180/5	1800	1760	149	50	4,81	192,5	245,2	170	64	196	73	221	83
E2180/6	1800	1760	149	60	4,84	203,5	258,7	170	64	196	73	221	83
E2200/3	2000	1960	149	30	5,29	172,4	220,3	170	69	196	79	221	90
E2200/4	2000	1960	149	40	5,31	193,0	246,1	170	69	196	79	221	90
E2200/5	2000	1960	149	50	5,33	213,1	271,7	170	69	196	79	221	90
E2200/6	2000	1960	149	60	5,36	225,1	286,3	170	69	196	79	221	90
E2220/3	2200	2160	149	30	5,81	188,7	241,3	170	71	196	81	221	92
E2220/4	2200	2160	149	40	5,83	210,9	269,0	170	71	196	81	221	92
E2220/5	2200	2160	149	50	5,85	234,1	298,7	170	71	196	81	221	92
E2220/6	2200	2160	149	60	5,88	246,8	314,1	170	71	196	81	221	92
E2250/3	2500	2460	149	30	6,59	213,6	273,6	170	82	196	94	221	106
E2250/4	2500	2460	149	40	6,61	237,9	303,7	170	82	196	94	221	106
E2250/5	2500	2460	149	50	6,63	266,2	340,1	170	82	196	94	221	106
E2250/6	2500	2460	149	60	6,66	279,8	356,3	170	82	196	94	221	106

Виды подключений

Цена в Евро

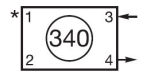
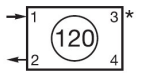

0,00

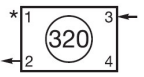
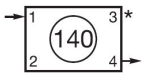

20,00

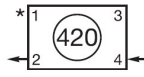
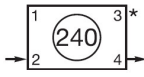

23,00

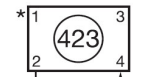
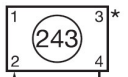
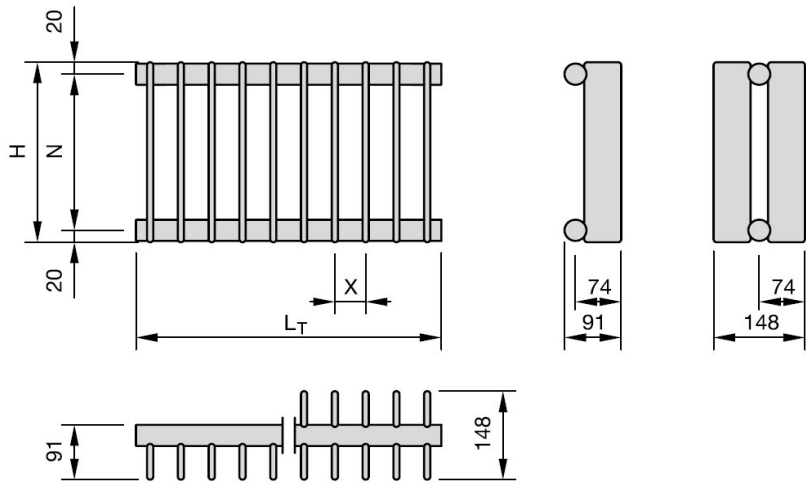
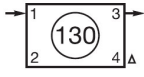

60,00

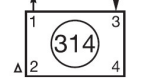
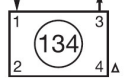

65,00

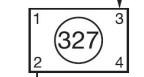
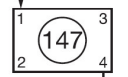

41,00

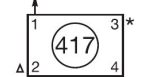

83,00

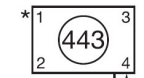
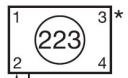
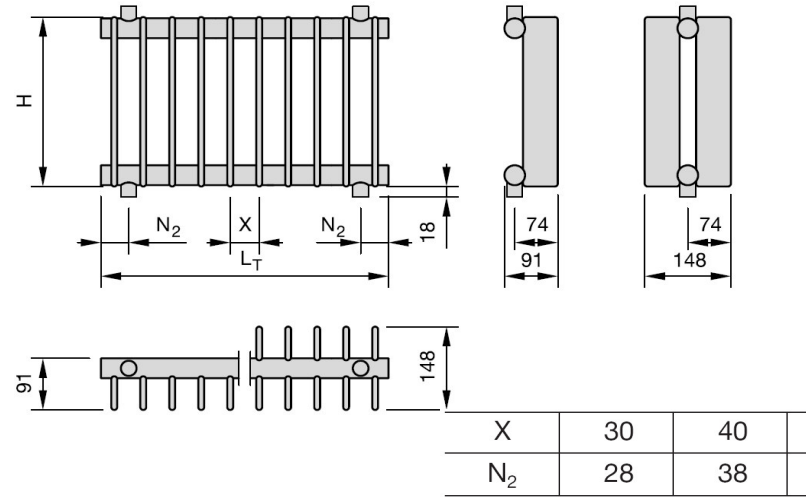

60,00

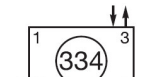
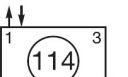
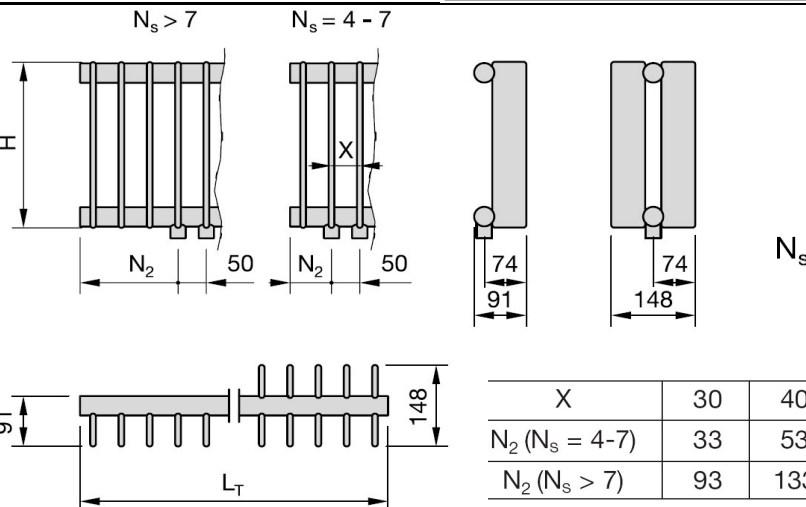

65,00

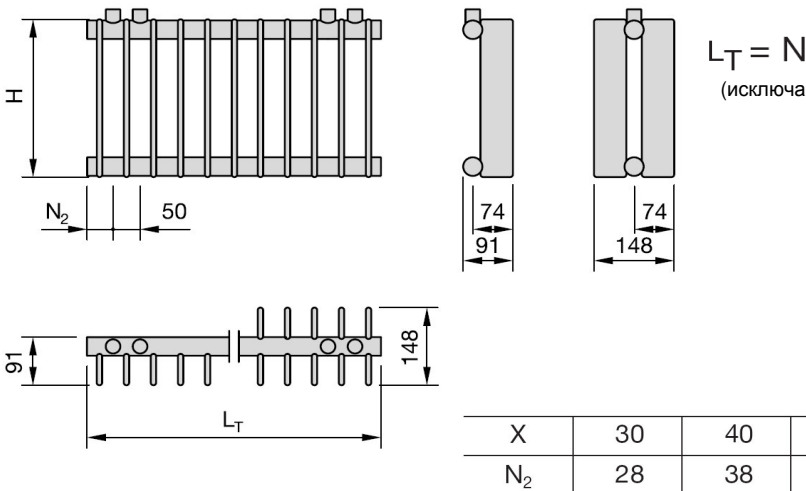

Виды подключений

Цена в Евро

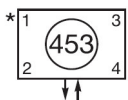
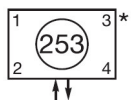

103,00

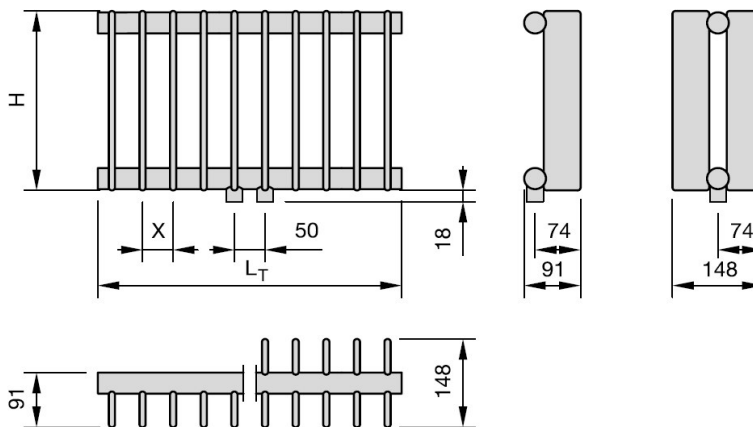

**Completo без термостатической головки (возможно начиная с 6 элементов)**

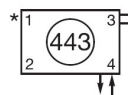
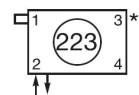

144,00

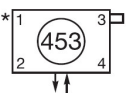
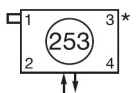
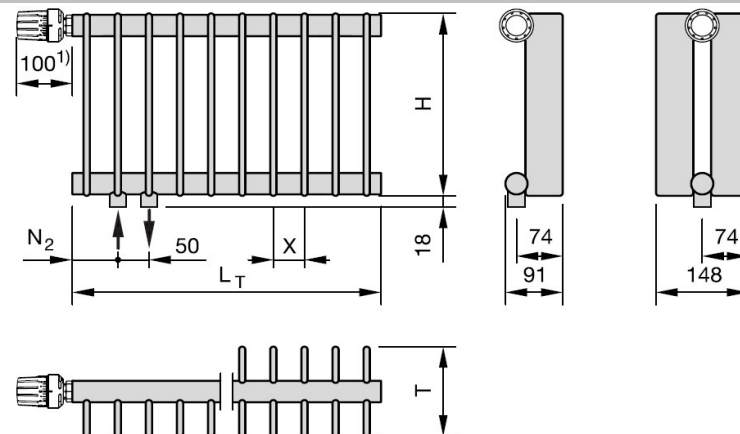

236,00

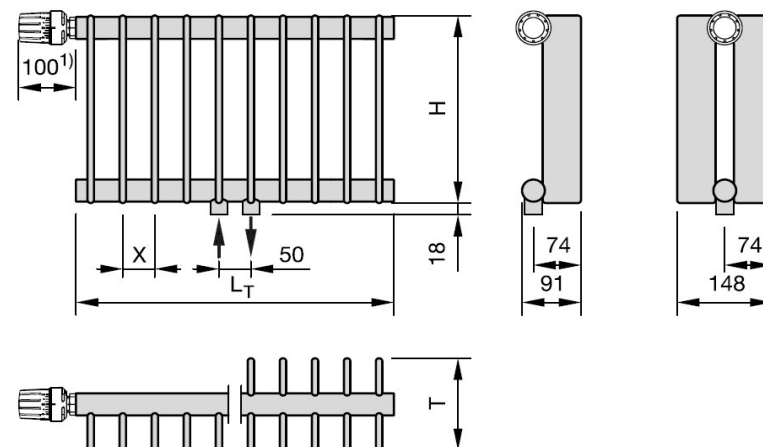

Повышенное давление 8 атм.

+12%

Приварные ноги, евро/шт

75,00

(для р-ров высотой до 600мм)



Высота  
100-150 мм  
150-200 мм  
200-250 мм

Кол-во эл-тов р-ра

Кол-во ног

4-28

2

29-60

3

61-80

4

81-100

5